

**Gospower**



**GPLB-24314M**

**Instruction Manual**  
V1.0

**LiFePO<sub>4</sub>**

[www.gospowerpv.com](http://www.gospowerpv.com)  
Tel: +86-755-2966-9919  
E-mail: [support.solar@gospower.com](mailto:support.solar@gospower.com)

# Catalog

- PREFACE** ..... 01
  - 1.1. Summary ..... 01
  - 1.2. Reader object ..... 01
  - 1.3. Symbolic Convention ..... 01
- SAFETY PRECAUTIONS** ..... 02
  - 2.1. General security ..... 02
  - 2.2. Personnel requirements ..... 05
  - 2.3. Electrical safety ..... 05
- PRODUCT INTRODUCTION** ..... 06
  - 3.1 Productintroduction ..... 06
  - 3.2 Appearance description ..... 07
    - 3.2.1 Normal performance ..... 07
    - 3.2.2 Terminal definition ..... 08
    - 3.2.3 Label ..... 09
  - 3.3 System diagram ..... 09
- PRODUCTINSTALLATION** ..... 10
  - 4.1 Unpacking inspection ..... 10
  - 4.2 Basicinstallation requirements ..... 10
  - 4.3 Ladder use safety ..... 11
  - 4.4 Drilling safety ..... 11
  - 4.5 Safety of handling heavy objects ..... 11
  - 4.6 Installation guidelines ..... 11
- ELECTRICAL CONNECTION** ..... 13
  - 5.1 Cable connection ..... 13
  - 5.2 communicationline connection ..... 13
    - 5.2.1 RJ45 communication point definition ..... 13
    - 5.2.2 RJ11 communication point definition ..... 13
  - 5.3 System connection diagram ..... 14
  - 5.4 Battery connection ..... 15
    - 5.4.1 Single battery connection ..... 15
    - 5.4.2 Multiple batteries in parallel ..... 16
- SYSTEM TUNING** ..... 18
  - 6.1 Check before power on ..... 18
  - 6.2 Battery function description ..... 18
    - 6.2.1 Buzzeraction description ..... 18
    - 6.2.2 RST key description ..... 18
    - 6.2.3 Sleep and wake up ..... 18
    - 6.2.4 Calibration specification ..... 18
    - 6.2.5 LCD ..... 19
- MAINTENANCE AND REQUIREMENTS** ..... 20
- BATTERY STORAGE REQUIREMENTS** ..... 20
- WARRANTY PRODUCTS** ..... 21
- EXEMPTION FROM LIABILITY** ..... 21

## PREFACE

### 1.1 Summary:

This document mainly introduces the product introduction, application scenario, installation, commissioning, system maintenance and technical data of wall mounted household energy storage battery and battery expansion module.





### 1.2 Reader object:

This document is mainly applicable to the following Engineers:

- ◆ Marketing Engineer
- ◆ System Engineer
- ◆ Technical support engineer

### 1.3 Symbolic Convention:

The following symbols may appear in this article, and they represent the following meanings:

Symbol	Explanation
 <b>DANGER</b>	Indicates a hazard with high risk that will lead to death or serious injury if not avoided.
 <b>Warning</b>	Indicates a hazard with medium risk that may lead to death or serious injury if not avoided.
 <b>Attention</b>	Indicates a hazard with low-level risk that may cause slight or moderate injury if not avoided.
 <b>Notice</b>	It is used to transmit equipment or environmental safety warning information. If not avoided, it may lead to equipment damage, data loss, equipment performance degradation or other unpredictable results. The "instructions" do not involve personal injury.
 <b>Explanation</b>	Indicates a hazard with high risk that will lead to death or serious injury if not avoided.

# SAFETY PRECAUTIONS

## 2.1 General security

### Statement

When installing, operating and maintaining the equipment, please read this manual first and follow the signs on the equipment and all safety precautions .

The "notice", "attention", "warning" and "danger" in the manual do not represent alsafety precautions to be observed, but only supplement all safety precautions. The company shall not be liable for any violation of general safety operation requirements or safety standards for design, production and use of equipment.

The equipment shall be used in an environment that meets the requirements of design specifications, otherwise it may cause equipment failure, and the resulting equipment function abnormalities or component damage, personal safety accidents, property losses, etc. Are not within the scope of equipment quality assurance. The installation, operation and maintenance of the equipment shall comply with local laws, regulations and specifications. The safety precautions in the manual are only a supplement to local laws, regulations and specifications.

#### The company shall not be liable for any of the following circumstances.

- ◆ Do not operate under the service conditions described in this manual.
- ◆ The installation and use environment exceeds the provisions of relevant international or national standards.
- ◆ Disassemble, change the product or modify the software code without authorization.
- ◆ Failure to follow the operation instructions and safety warnings in the product and documents.
- ◆ Transportation damage caused by customer's own transportation.
- ◆ Damage caused by storage conditions not meeting the requirements of product documents.

### General requirements

#### DANGER

Live operation is strictly prohibited during installation.

- ◆ It is strictly prohibited to install, use and operate outdoor equipment and cables (including but not limited to handling equipment, operating equipment and cables, plug and unplug signal interfaces connected to outdoor, high-altitude operation, outdoor installation, etc.) in severe weather such as lightning, rain, snow and force gale.
- ◆ After installing the equipment, the empty packaging materials such as cartons, foam, plastic, tie line should be removed.
- ◆ In case of fire, evacuate the building or equipment area and press the fire alarm below the fire alarm telephone. Under no circumstances shall re-enter the burning building.
- ◆ It is strictly prohibited to artificially alter, damage or block the identification and nameplate on the equipment.

- ◆ When installing the equipment, use tools to tighten the screws.
- ◆ Paint scratches during equipment transportation and installation must be repaired in time. It is strictly prohibited to expose the scratched parts to the outdoor environment for a long time.
- ◆ Do not open the main panel of the device without the permission of the manufacturer.
- ◆ In any case, do not change the structure and installation sequence of the equipment without the permission of the manufacturer.
- ◆ It is forbidden to affect the battery terminal components during handling, and it is not allowed to lift and handle through the battery terminal bolts.
- ◆ It is not allowed to reverse engineer, decompile, disassemble, adapt, implant or other derivative operations on the equipment software, and it is not allowed to study the internal implementation of the equipment in any way.

### Personal safety

- ◆ Wear appropriate personal protective equipment during equipment operation. In case of any fault that may cause personal injury or equipment damage, the operation shall be terminated immediately, the person in charge shall be reported, and effective protective measures shall be taken.
- ◆ Before using the tool, please master the correct use method of the tool to avoid personal injury and equipment damage.
- ◆ When the equipment is running, the shell temperature is high and there is a risk of burns. Do not touch it.
- ◆ In case of battery failure, the temperature may exceed the burn threshold of the touchable surface, and contact should be avoided.
- ◆ Do not open or damage the battery. The released electrolyte is harmful to the skin and eyes. Avoid contact.
- ◆ Do not place irrelevant items on the top of the equipment or insert them anywhere in the equipment.
- ◆ Do not place inflammables around the equipment.
- ◆ The battery shall not be placed in the fire to avoid explosion and endanger personal safety.
- ◆ Do not place the battery module in water or other liquids.
- ◆ Do not short-circuit the battery terminal, which may cause combustion.
- ◆ The battery may cause the danger of electric shock and large short-circuit current. When using the battery, pay attention to the following precautions:
  - a) Remove watches, rings or other metal objects.
  - b) Tools using insulated handles.
  - c) Wear rubber gloves and boots.
  - d) Do not place tools or metal parts on the top of the battery.
  - e) Disconnect the charging power supply before connecting or disconnecting the battery terminal.
- ◆ Do not use water or detergent to clean the electrical parts inside and outside the cabinet.

- ◆ Do not stand or lean on or sit on the equipment.
- ◆ Do not damage each module of the equipment.
- ◆ When installing the battery module, if the battery module falls or is strongly impacted, the equipment will be damaged. It is strictly prohibited to continue to use, otherwise there will be safety risks (cell leakage, electric shock injury, etc.).

### Treatment measures for battery leakage

In case of electrolyte leakage, avoid contact with leaked liquid or gas. Electrolyte is corrosive and contact may cause skin irritation and chemical burns. In case of contact with battery electrolyte, the following measures shall be taken.

Inhalation: evacuate the contaminated area, enter fresh air immediately, and seek medical help immediately.

Eye contact: immediately flush eyes with plenty of water for at least 15 minutes, do not rub, and seek medical help immediately.

Skin contact: immediately wash the contact area with plenty of water and soap and seek medical help immediately.

Ingestion: seek medical help immediately.

### Fire treatment measures

- ◆ In case of fire, the system should be powered off under the condition of ensuring safety.
- ◆ Use carbon dioxide, FM-200 or ABC dry powder fire extinguisher to extinguish the fire.

#### DANGER

When the battery temperature is too high, it will cause battery deformation, damage, electrolyte overflow and toxic gas leakage. Please keep away from it to avoid skin irritation and chemical burns.

### Flood emergency measures

- ◆ Power down the system to ensure personal safety.
- ◆ If any part of the battery is flooded, do not touch the battery to avoid electric shock.
- ◆ Do not use the flooded battery. Contact the battery recycling company for scrapping.

### Battery recycling

- ◆ Please dispose of waste batteries according to local laws and regulations. Do not treat batteries as domestic waste.
- ◆ If the battery leaks or bulges, please contact technical support or battery recycling company for scrapping.
- ◆ When the battery is unavailable beyond its service life, please contact the battery recycling company for scrapping.
- ◆ Avoid exposing the battery to high temperature or direct sunlight.
- ◆ Avoid exposing the battery to high humidity or corrosive environment.

## 2.2 Personnel requirements

- ◆ The personnel responsible for the installation and maintenance of this equipment must understand various safety precautions and master the correct operation methods.
- ◆ Only qualified professionals or trained personnel are allowed to install, operate and maintain the equipment.
- ◆ Only qualified professionals are allowed to dismantle safety facilities and overhaul equipment.
- ◆ Personnel operating the equipment, including operators, trained personnel and professionals, shall have the special operation qualification required by the local state.
- ◆ The replacement of equipment or components (including software) must be completed by professionals or authorized personnel.

### Explanation

- ◆ Professionals: those who have training or experience in operating equipment and can understand the potential sources and magnitude of hazards in the process of equipment installation, operation and maintenance.
- ◆ Trained personnel: personnel who have received corresponding technical training and have necessary experience, can be aware of the risks that may be brought to him during a certain operation, and can take measures to minimize the risks to himself or other personnel.
- ◆ Operators: operators who may come into contact with the equipment other than trained personnel and professionals.

## 2.3 Electrical safety

### General requirements

#### DANGER

Before making electrical connection, please ensure that the equipment is not damaged, otherwise electric shock or fire may be caused.

- ◆ All electrical connections must meet the national electrical standards.
- ◆ The cable provided by the user shall meet the requirements of local laws and regulations.
- ◆ Use special insulating tools for high voltage operation.

### DC operation

#### DANGER

It is forbidden to install or remove the power line with electricity. When the power cord contacts the conductor, it will produce arc or electric spark, which can lead to fire or personal injury.

- ◆ Before the electrical connection of the equipment, if the live parts may be touched, the corresponding breaking device at the front level of the equipment must be disconnected.
- ◆ Before connecting the power cord, confirm that the label identification of the power cord is correct before connecting.

- ◆ If the equipment has multiple inputs, all inputs of the equipment shall be disconnected, and the equipment can be operated only after the equipment is completely powered off.

### Wiring requirements

- ◆ The use of the cable in high temperature environment may cause aging and damage of the insulating layer. The distance between the cable and the periphery of the heating device or heat source area shall be at least 30mm.
- ◆ Similar cables shall be bound together, and different types of cables shall be laid at east 30mm apart. Mutual winding or cross laying is prohibited.
- ◆ The cables used must be firmly connected, well insulated and of appropriate specifications.

## PRODUCT INTRODUCTION

### 3.1 Product introduction

#### Function

:Li-ion battery includes only battery modules, which can store and release electric energy according to the requirements of inverter management system. The input and output ports of battery are 25.6V DC.

- ◆ Battery charging: the power control module is connected with the energy storage terminals (BAT+, bat-) of the inverter to charge the battery and store the excess photovoltaic energy in the battery under the control of the inverter.
- ◆ Battery discharge: when the photovoltaic energy is insufficient to supply power to the load, the system needs to control the battery to supply power to the load and output the stored battery energy to the load through the inverter.

#### Model

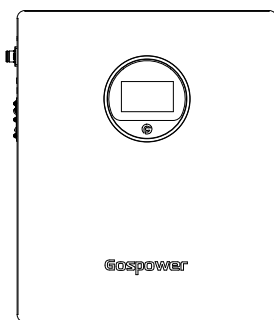

NO.	Voltage	Capacity	IP Level
01	25.6V	314Ah	IP 20

## 3.2 Appearance description

### 3.2.1 Normal performance

NO.	Item	General Parameter		Remark
01	Combination method	8S1P		LiFePO <sub>4</sub>
02	Rated Capacity	Typical	314Ah	0.5C,@25°C
		Minimum	314Ah	0.5C,@25°C
03	Rated Voltage	25.6Vdc		
04	Factory SOC	40%~45%		
05	Voltage at end of discharge	21.6Vdc		Discharge Cut-off Voltage
06	Charging mode	CC-CV MAX29.2Vdc		
07	Internal Impedance	≤25mΩ		Internal resistance measured at AC 1KHZ after 50% charge
08	Standard charge current	150A		Charge time: Approx 2.5h
09	Maximum Charge Current	150A		
10	Standard discharge	200A		
11	Maximum Discharge Current	210A		
12	Operation Temperature Range	Charge	0~55°C	Bare Cell 60±25%R.H
		Discharge	-20~55°C	
13	Storage Temperature Range	-30~65°C		Bare Cell 60±25%R.H
14	Dimensions	L603*W500*H190mm		
15	Weight	65kg		
16	Communication mode	RS485/RS232/CAN		
17	Maximum series number	Forbid		
18	Maximum number of parallels	16PCS		
19	Mass energy ratio	123Wh/kg		

### 3.2.2 Terminal definition

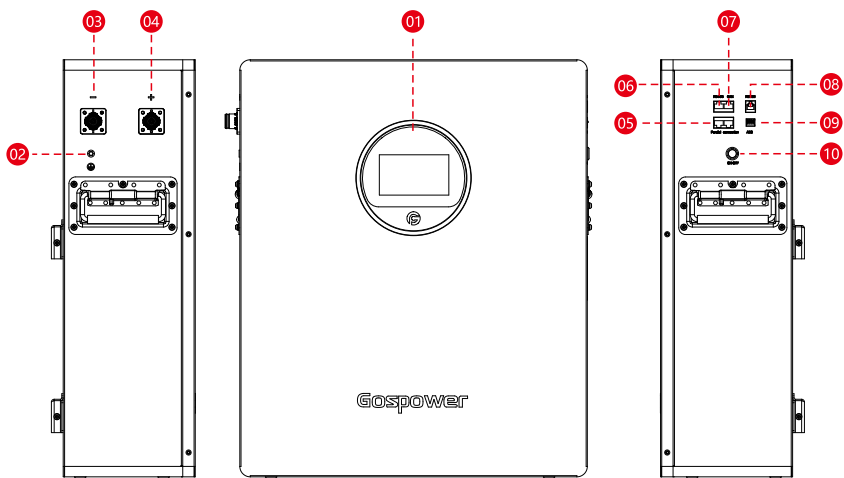

NO.	Description	Functional Description
01	LCD	Display battery status information
02	Ground wire	Battery ground wire
03	Battery-	Negative terminal
04	Battery+	Positive terminal
05	CAN	CAN communication interface (Used in communication parallel, and for battery condition monitoring or manufacturer to debug or service)
06	RS485	RS485 communication interface
07	CAN	CAN communication interface
08	RS232	RS232 communication interface (for battery condition monitoring)
09	ADS Dialer	Display connection address
10	Reset key	ON/OFF button

### 3.2.3 Label

Gospower

Model type:GPLB-24314M	
Rated capacity:314Ah	Watt-hour:8038WH
Nominal voltage:25.6V	Weight of battery:65Kg
LITHIUM IRON PHOSPHATE BATTERY PACK(LiFePO4)	
Battery designation:IFpP74/174/206/[8S]M/-30+60/95	
Recommended charge:150A(0.5C) charge to 29.2V CC/CV	
Max charge/discharge current (A):150A/200A	

WARNING

CONSULT THE USERS MANUAL PRIOR TO OPERATING THE BATTERY!

WARNING: Risk of fire explosion or burns;

- DO NOT short the battery terminals.
- DO NOT incinerate crush or disassemble.
- DO NOT reverse connections (polarity) from charge to battery.
- DO NOT over charge or over discharge.
- DO NOT operate battery beyond published voltage current and temperature limits.

### 3.3 System diagram

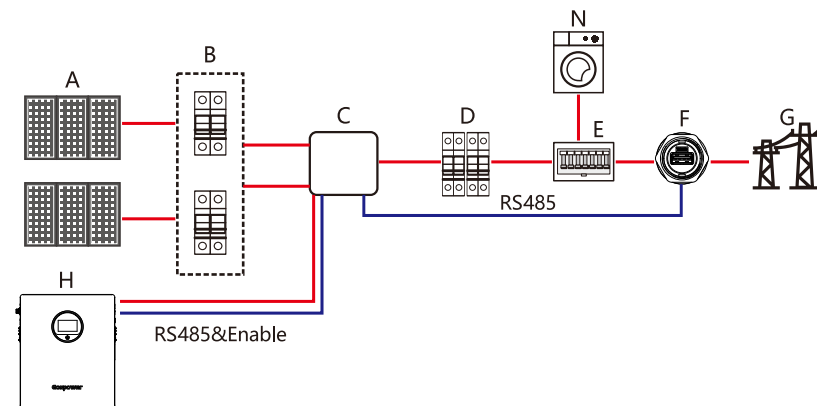

- |                |                            |                                 |
|----------------|----------------------------|---------------------------------|
| (A) PV module  | (B) DC switch              | (C) Inverter                    |
| (D) AC switch  | (E) Power Distribution Box | (F) Intelligent power collector |
| (G) Power grid | (H) Battery                | (N) Load                        |

**Explanation**

- ◆ The input and output of the battery energy storage system are connected to the energy storage port of the inverter.
- ◆ Following are the modes to communicate with the battery energy storage system:
  - The Inverter can be connected through CAN/RS485 interface to realize the communication and control between the inverter and battery.

## PRODUCT INSTALLATION

### 4.1 Unpacking inspection

Please confirm whether the outer package of the product is damaged before unpacking. After unpacking, please carefully check the product for damage or missing accessories. In case of damage or missing accessories, please contact the supplier directly for assistance.

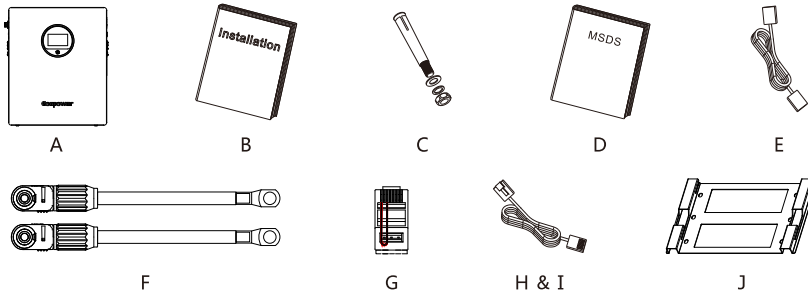

NO.	QTY	Description
A	1	Battery PACK
B	1	Instructions
C	6	Expansion screws M10
D	1	MSDS Transportation certificate
E	1	RS232 communication line
F	2	Cable 1.5m
G	1	Parallel matching resistor
H	n	Parallelline: Customized according to customers
I	n	RS485 communication line: Customized according to customers
J	1	Wall mounting bracket

### 4.2 Basic installation requirements

- ◆ Shall be installed in a dry and well-ventilated area to ensure good heat dissipation.
- ◆ Recommended to choose a sheltered installation site or under a sunshed, indoor is more preferable option.
- ◆ Avoid direct sunlight or rain. The surrounding environment should be clean and free from large infrared radiation, organic solvents and corrosive gases.

### 4.3 Ladder use safety

- ◆ Wooden ladder or FRP ladder shall be used when power climbing operation may be involved.
- ◆ When using the herringbone ladder, the pulling rope must be firm, and someone must hold the ladder during operation.
- ◆ Before using the ladder, please confirm that the ladder is intact, the bearing weight of the ladder meets the requirements, and overweight is strictly prohibited.
- ◆ When using the ladder, the wide foot of the ladder shall face down or protective measures shall be taken at the bottom of the ladder to prevent slipping.
- ◆ The ladder should be placed in a stable place. The gradient of the ladder should be 75°, which can be measured with an angle ruler, as shown in the figure below.

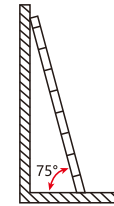

- ◆ When climbing the ladder, please pay attention to the following actions to reduce danger and ensure safety:
  - ◆ Keep your body steady.
  - ◆ The maximum height of operators standing on their feet shall not exceed the fourth step of the ladder from top to bottom.
  - ◆ Ensure that the center of gravity of the body does not deviate from the edge of the ladder.

### 4.4 Drilling safety

The following safety precautions shall be considered when drilling on the wall and ground:

- ◆ Wear goggles and protective gloves when drilling.
- ◆ During drilling, the equipment shall be covered to prevent debris from falling into the equipment. After drilling, the debris shall be cleaned.

### 4.5 Safety of handling heavy objects

- ◆ When carrying heavy objects, be prepared to bear the load to avoid being crushed or sprained by the heavy objects.

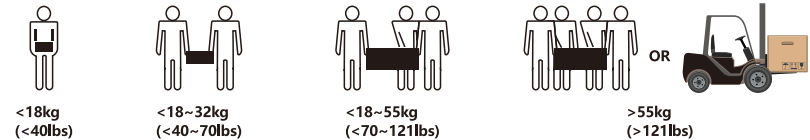

- ◆ When handling the equipment by hand, wear protective gloves to avoid injury.

### 4.6 Installation guidelines

- ◆ Determine the exact location of battery installation; If it is wall mounted, the wall thickness shall be greater than or equal to 100mm;
- ◆ Use the mounting bracket or cardboard to determine the specific location of the hole; Keep the top edge of the cardboard horizontal.
- ◆ Drill 6 holes at the marked position with the hole diameter of  $\phi 8$ ; The hole depth shall not be less than 55mm.
- ◆ Knock 6 expansion screws into the drilled holes.
- ◆ Hang the battery mounting bracket on the screw.

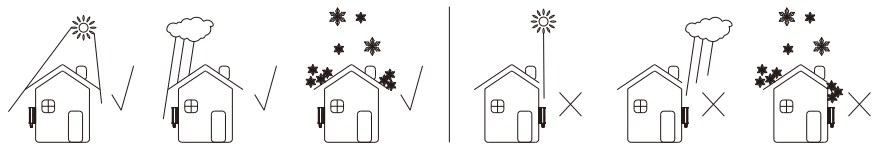

- ◆ The installation location shall be reasonably away from the fire source.
- ◆ The installation location shall not be accessible by the children.
- ◆ The installation location shall be sufficiently away from water sources, such as water tap, sewer pipe, sprinkler etc., to avoid water infiltration.
- ◆ The installation wall shall be strong enough to carry the weight of the battery for a long time, please follow local standard or best practice guidelines.
- ◆ Do not place inflammables and explosives around the battery.
- ◆ When the battery is running, do not block the vent or cooling system. Maintain the battery operating temperature for charging 0-55°C and discharging -20 ~ 60°C.
- ◆ Do not store or install the battery in an environment of flammable or explosive gas or smoke. Any operation of the battery in such environment is strictly prohibited.
- ◆ The battery can be installed on a vertical or backward inclined plane. Please refer to the following figure:

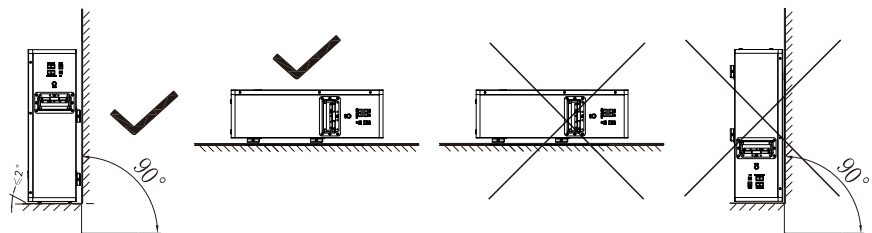

◆ **Wall mounted installation method:**

Firstly, align the wall bracket parallel to the wall, and then install expansion screws according to the holes on the bracket to ensure that the screws fix the bracket in place. Then, snap the four support points on the back of the battery pack into the snap grooves of the wall bracket, and the installation is complete.

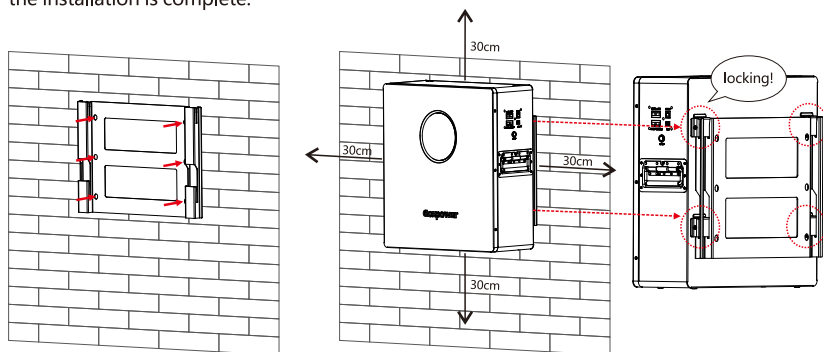

## ELECTRICAL CONNECTION

### 5.1 Cable connection

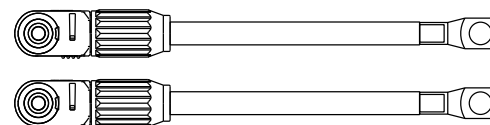

A

Anderson connector is used on the DC input side of the battery energy storage system. The specific connections are as follows:

NO.	Terminal	Cable diameter	Length	Description
A	Quick connector /SC35-8	35mm <sup>2</sup>	1-3m	Used for connection between battery and inverter

### 5.2 Communication line connection

#### 5.2.1 RJ45 Communication point definition (8P8C)



PIN	RS485	CAN
1	RS485-B	NC
2	RS485-A	GND
3	GND	NC
4	NC	CANH
5	NC	CANL
6	GND	NC
7	RS485-A	GND
8	RS485-B	NC

#### 5.2.2 RJ11 Communication point definition (6P6C)



PIN	RS232
1	NC
2	NC
3	TX
4	RX
5	GND
6	+5V (External power wake-up)

**Explanation**

- ◆ **RS232 communication:** BMS can communicate with the computer through RS232 interface to check battery health related information including battery voltage, current, temperature, and manufacturer's default data.
- ◆ **RS485 / CAN communication:** CAN communication connects the battery with the inverter to function as duo for operations.
- ◆ **RS485 communication:** The additional two RS485 interfaces can be used for parallel connections with other batteries, or to monitor battery health conditions including debugging and routine servicing Addresses PIN: 1-8.
- ◆ Different inverter communication protocols have different pin definitions. Please pay attention to the compatibility between the battery and inverter CAN/RS485 communication line.

**5.3 System connection diagram**

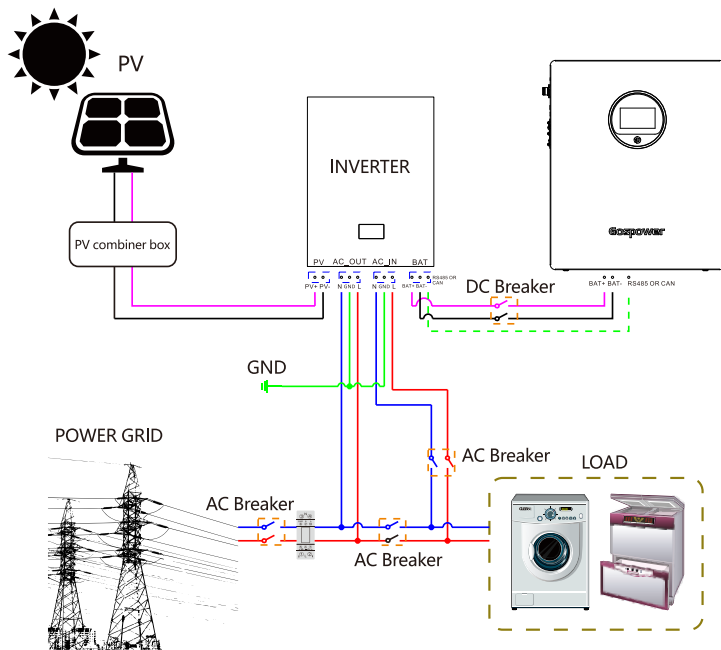

Cable color	Description	Cable color	Description
	DC positive wire		Live Wire
	DC negative wire		Naught wire
	Ground wire		Communication line

**5.4 battery connection**

**5.4.1 Single battery connection**

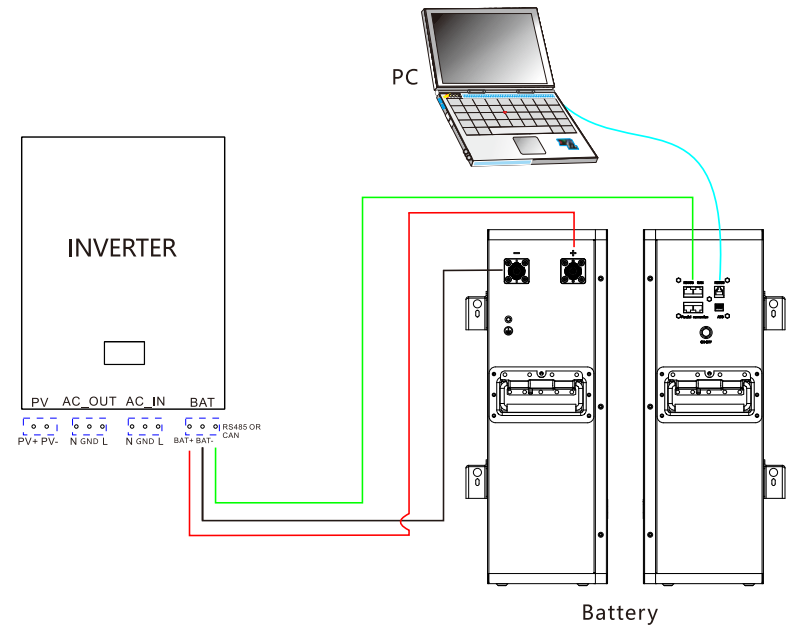

Cable color	Description	Cable color	Description
	DC positive wire		RJ45 Communication Line RS485/CANcommunication
	DC negative wire		RS232 communication Line

### 5.4.2 Multiple batteries in parallel

**NOTE: If there are multiple batteries (two or more) in parallel, please charge the SOC of each battery to 100% before the parallel!!!**

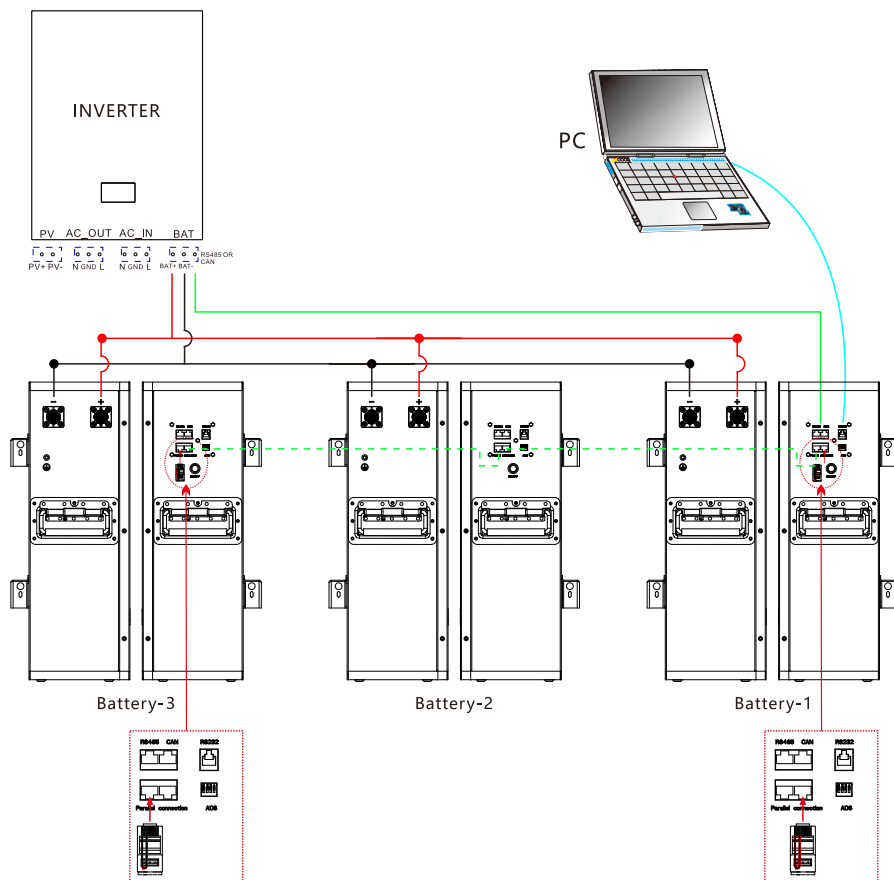

**NOTE:** The powerlines between each battery are the same length.

Cable color	Description	Cable color	Description
	DC positive wire		RS232 communication Line
	DC negative wire		Parallel Communication Line
	RJ45 Communication Line RS485/CANcommunication		Parallel matching resistor (When using multiple parallel machines)

### Explanation

◆ The maximum number of batteries can only be connected in parallel is 16pcs. After parallel connection, the address of ads needs to be assigned, as shown below:

Address	Dial switch					Remark
	#1	#2	#3	#4		
0	OFF	OFF	OFF	OFF		Battery PACK1 (Main PACK)
1	ON	OFF	OFF	OFF		Battery PACK2
2	OFF	ON	OFF	OFF		Battery PACK3
3	ON	ON	OFF	OFF		Battery PACK4
4	OFF	OFF	ON	OFF		Battery PACK5
5	ON	OFF	ON	OFF		Battery PACK6
6	OFF	ON	ON	OFF		Battery PACK7
7	ON	ON	ON	OFF		Battery PACK8
8	OFF	OFF	OFF	ON		Battery PACK9
9	ON	OFF	OFF	ON		Battery PACK10
10	OFF	ON	OFF	ON		Battery PACK11
11	ON	ON	OFF	ON		Battery PACK12
12	OFF	OFF	ON	ON		Battery PACK13
13	ON	OFF	ON	ON		Battery PACK14
14	OFF	ON	ON	ON		Battery PACK15
15	ON	ON	ON	ON		Battery PACK16

- ◆ The inverter only needs to communicate with the host (Pack1).
- ◆ When multiple batteries are connected with multiple inverters, it is best to connect through the combiner box. If it is not connected through the combiner box, the wiring mode shall be confirmed with the manufacturer's agent. And the cable from each battery to the inverter remains the same length.
- ◆ Suggestion: When battery packs are used in parallel, ensure that the capacity is the same. The capacity difference is less than 5%. If the capacities are inconsistent, fill or empty them separately, keep the capacities consistent, and then use them in parallel.

### Notice

- ◆ Batteries are not allowed to be connected in series.
- ◆ Different batteries with different chemistries, different batches of batteries from the same chemistry and technical design parameters can not be bundled and used together.

# SYSTEM TUNING

## 6.1 Check before power on

NO.	Inspection items	Acceptance criteria
1	The energy storage battery is installed in place	The installation is correct, firm and reliable.
2	Reasonable cable layout	The cable layout is reasonable to meet the user's requirements.
3	Beautiful binding of cable ties	The cable ties shall be uniform and no sharp corners shall be left at the cut.
4	Reliable grounding	The ground wire is connected correctly, firmly and reliably.
5	The cable is connected in place	The DC input line, energy storage line and signal line are connected correctly, firmly and reliably.
6	Insulate unused terminals and interfaces	Install insulating tape on unused terminals and interfaces.
7	The installation environment meets the requirements	The installation space is reasonable, the environment is clean and tidy, and there is no construction residue.

After the inspection, press and hold the RST key (1S) and release it, the protection board is activated. The RUN indicator light starts flashing in the flashing 1 mode.

## 6.2 Batteryfunction description

### 6.2.1 Buzzer action description

When the system generates protection or faults, it beeps for 1 second every 15 seconds. The buzzer function can be enabled or disabled through the upper computer, and is disabled by default at the factory.

### 6.2.2 ON/OFF key description

- ◆ When the BMS is in a sleep state, press the button for 1 second and release it. The protection board is activated, the screen starts to light up.
- ◆ When the BMS is in an active state, press the button for 3 to 5 seconds, Wait until the screen is off. At this time, the protection board is dormant.

### 6.2.3 Sleep and wake up

#### Sleep:

When any of the following conditions occurs, the system enters into the low power consumption mode:

- ◆ The standby time exceeds 24 hours (no communication, no charging or discharging).
- ◆ Press the key (3~5S) and release the key.
- ◆ Force sleep through PC software.

### 6.2.4 Calibration specification

- ◆ Tip: Perform SOC correction every six months. Procedure: Remove the battery and PCS communication cable, charge and discharge it for a 0.5C cycle, and then reconnect the PCS and battery communication cable for normal use.

#### Notice

Before entering sleep, it is necessary to ensure that the input terminal is not connected to external voltage, otherwise it will not be able to enter sleep mode normally.

#### Wake up:

When the system is in the low power consumption mode and meets any of the following conditions, the system will exit the low power consumption mode and enter into the normal operation mode:

- ◆ Connect the charger, and the output voltage of the charger shall be greater than 48V.
- ◆ Press the button for 1 second and then release it.
- ◆ The 5V voltage of the RS232 communication interface is activated.

## 6.2.5 LCD



- ◆ Startup Picture

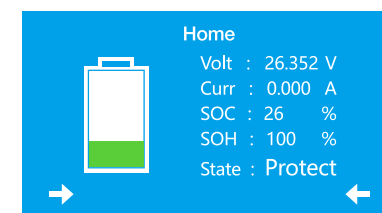

- ◆ The Home page displays battery voltage, current, charge, and status.

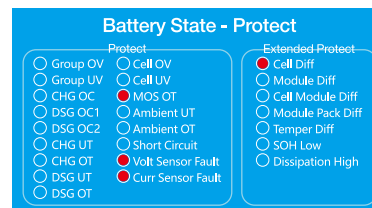

- ◆ The battery state-protect page displays various protection information. If a certain alarm value is triggered, yellow is displayed. If a protection value is triggered, red is displayed.

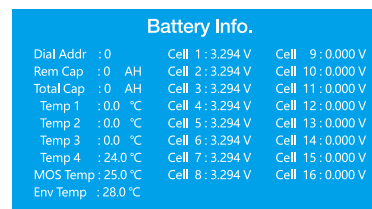
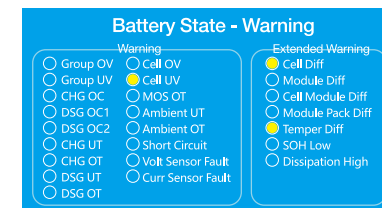

- ◆ On the Battery info page, the cell temperature, ambient temperature, and MOS temperature are displayed on the left, and the voltage values for each of the 16 cells are displayed on the right.



- ◆ In the system information page, the serial number, communication protocol, protocol version and language will be displayed. When you need to communicate with different inverters, you can choose the corresponding communication protocol.

- ◆ The screen will go off after 5 minutes of no operation.

## MAINTENANCE AND REPLACEMENT

- ◆ Please maintain the equipment when you are familiar with and understand the contents of this manual and have appropriate tools and test devices.
- ◆ Before carrying out maintenance work, please power down the equipment first, then follow the instructions of the delayed discharge label and wait for the corresponding time to ensure that the equipment has been powered down before operating the equipment.
- ◆ During maintenance, please try to avoid irrelevant personnel entering the maintenance site, and temporary warning signs or fences must be erected for isolation.
- ◆ If the equipment fails, please contact your dealer in time.
- ◆ The equipment can be powered on again only after the fault is handled, otherwise it may cause fault expansion or equipment damage.
- ◆ Do not open the cover plate without authorization, otherwise there will be a risk of electric shock, and the resulting failure does not belong to the scope of warranty.
- ◆ Operation and maintenance personnel and professional technicians shall be fully trained in safe use and equipment maintenance, and shall operate with sufficient preventive measures and personal protective equipment.
- ◆ Battery maintenance shall be performed or supervised by personnel familiar with the battery and its required precautions.
- ◆ After the maintenance operation, check immediately to ensure that no tools or other parts are missing in the equipment.

## BATTERY STORAGE REQUIREMENTS

- ◆ When the battery is stored, it shall be placed correctly according to the identification of the packing box, and shall not be placed upside down or on the side.
- ◆ When the battery packing box is stacked, it shall meet the stacking requirements on the outer package.
- ◆ The battery shall be handled with care, and it is strictly prohibited to damage the battery.
- ◆ Storage environment requirements:
  - a. Ambient temperature: -10°C~55°C, recommended storage temperature: 20°C~30°C.
  - b. Relative humidity: 35% RH ~ 85% RH.
  - c. Dry, ventilated and clean.
  - d. Avoid contact with corrosive organic solvents, gases and other substances.
  - e. Avoid direct sunlight.
  - f. The distance from the heat source shall not be less than two meters.
- ◆ When the battery is stored, it must be disconnected from the outside. If there is an indicator on the battery panel, the indicator should be off.
- ◆ The warehouse keeper shall count the battery storage every month and regularly report the battery inventory to the planning link. For batteries with storage time close to -20~25°C=6 months and -20~45°C=1 month, replenishment shall be arranged in time. The battery shall be charged once every three months (under the normal storage environment, long-term storage will lead to capacity attenuation and cycle life decline. If it exceeds the storage environment requirements, it will further aggravate the capacity attenuation and cycle life decline.)

- ◆ (When the stored batteries are shipped, the principle of first in first out shall be followed.
- ◆ Battery maintenance shall be performed or supervised by personnel familiar with the battery and its required precautions.
- ◆ After the battery production test is completed, it needs to be supplemented to 30-50% SOC at least before storage.

## WARRANTY PRODUCTS

Requirement:

During the warranty period, the company requires customers to provide invoices and dates for purchasing products. At the same time, the trademark on the product shall be clearly visible, otherwise it has the right not to provide quality assurance. The replaced products shall be handled by the company, and the customer shall leave a certain time for the company to deal with the faults.

## EXEMPTION FROM LIABILITY

The company has the right not to conduct quality assurance under the following circumstances:

- ◆ Beyond the free warranty period.
- ◆ Incorrect installation, modification or use.
- ◆ Operate in very harsh environments beyond those described in this manual.
- ◆ Failure due to damage caused by unauthorized installation, repair, change or disassembly.
- ◆ Failure due to damage caused by the use of non-standard components or software.
- ◆ Any installation and use beyond the scope specified in relevant international standards.
- ◆ Damage caused by abnormal natural environment.